

INSTALLATION, USE AND MAINTENANCE HANDBOOK FOR EI₂ 90, EI₂ 120 AND MULTIPURPOSE PROGET DOORS - BLOCK FRAME FOR IN THE REVEAL APPLICATION

EI₂ classification:

EI₂ 90: P.V. RS-12-077
EI₂ 120: P.V. RS-06-092

NINZ S.p.A.
corso Trento, 2/A
I-38061 ALA (TN) / ITALY

I66-GB

5001503/2
09/12

1/2

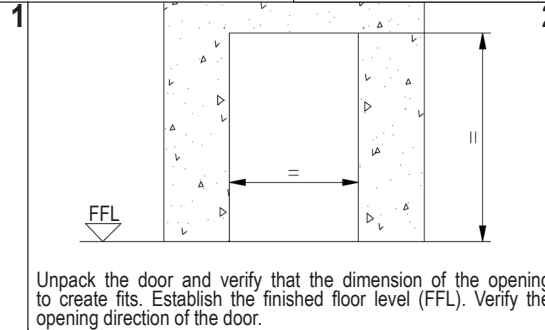
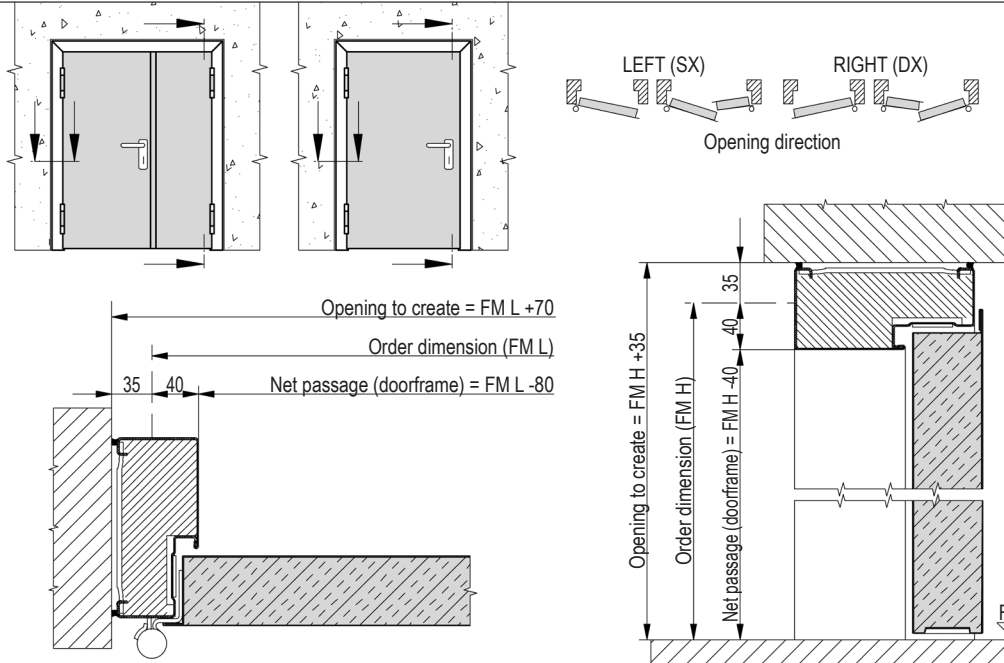

Unpack the door and verify that the dimension of the opening to create fits. Establish the finished floor level (FFL). Verify the opening direction of the door.

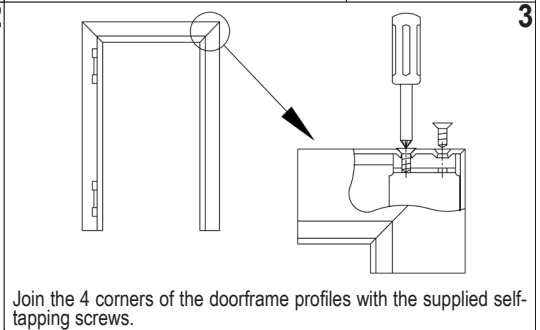

Join the 4 corners of the doorframe profiles with the supplied self-tapping screws.

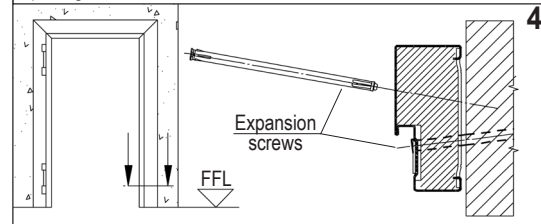

Fasten the doorframe in the wall respecting the plumb line, the FFL and fix it through the given holes, inserting spacers between the frame and the wall if necessary. Expansion screws recommended: for light wall - Würth type DBL-(WUS-SK)-Z3-180-10x202; for heavy wall - Spit type L 10-102/152 (not supplied).

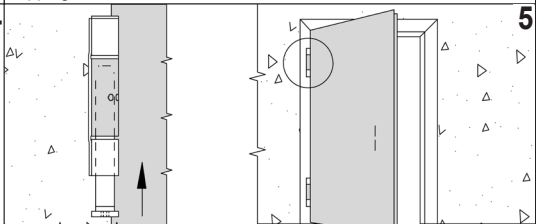

Unpack the door leaf without removing spacers and wedges, place it in the doorframe inserting the pivot with spring in upper hinge for leaf with left to pull opening direction and lower hinge for leaf with right to pull opening direction.

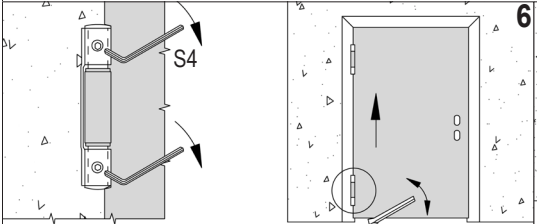

Close the leaf with the aid of a lever and hold raised it. Bring the main hinge bearings in contact with each other through the use of the screw thread. Operation to be carried out with the maximum care and without forcing.

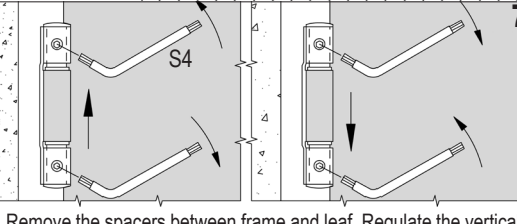

Remove the spacers between frame and leaf. Regulate the vertical leaf's position. To raise the door leaf: unscrew the upper blocking screw, screw on the lower one, screw on the upper one again. To lower the door leaf: unscrew the lower blocking screw, screw on the upper one. Operation to be carried out with the maximum care with the aid of a lever.

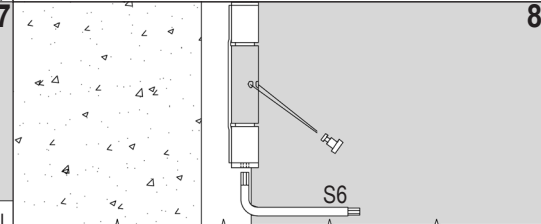

Wind up the spring hinge in the opening direction inserting the tension pin. Even if self closing is not needed or overhead doorclosers are installed, wind up the hinge spring anyway blocking it with the tension pin. The self closing it is mandatory for fire-rated doors.

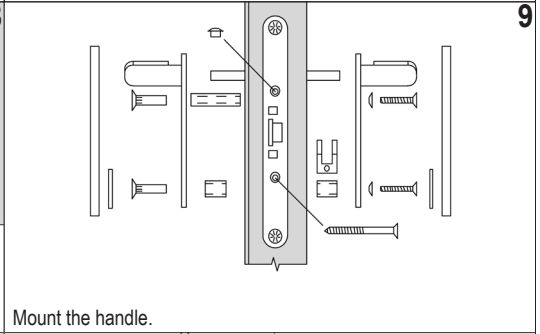

Mount the handle.

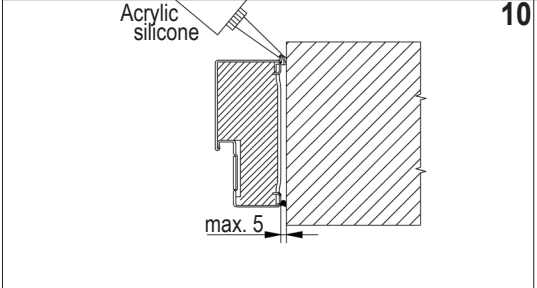

The silicone seam is at customer's expense. Fill up with mineral wool the gap between doorframe and wall if it is excessive.

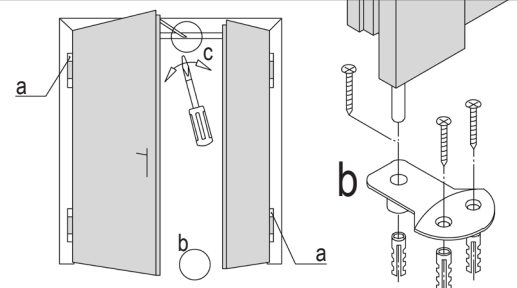

The closing regulator is mandatory only for fire-rated doors.

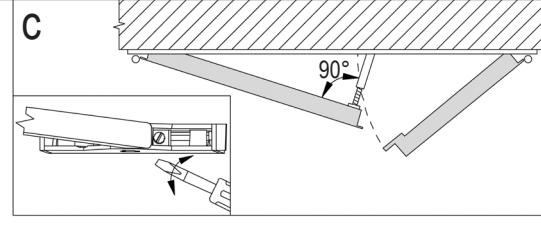

For double leaf doors use the same assemble procedure adding: a) load two pivot with springs; b) install the catch set in the floor; c) if present, regulate the sequencer (arm position perpendicular to the main leaf).

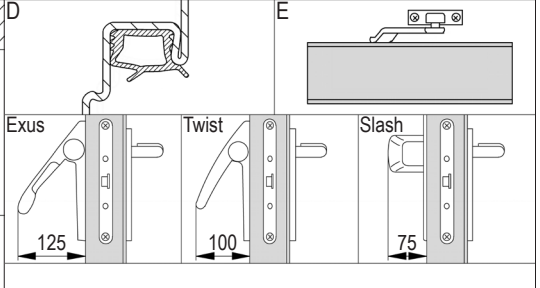

Optional: D) rebate sealing - E) overhead doorcloser (the spring must be anyhow slightly loaded) - Exus, Twist or Slash panic bar.

NOTE: multipurpose doors are not equipped with thermoexpanding gaskets, doorframe insulation and closing regulators.

INSTALLATION, USE AND MAINTENANCE HANDBOOK FOR EI₂ 90, EI₂ 120 AND MULTIPURPOSE PROGET DOORS BLOCK FRAME FOR IN THE REVEAL APPLICATION

I66-GB 2/2

GENERAL NOTES

STANDARD: the assemble instructions have to be followed in every detail to respect the test conditions and assure the perfect functioning of the door, including the self-closing for fire-rated doors. Furthermore a regular service is necessary. Multipurpose doors are not endowed with thermoexpanding gaskets, doorframe insulation and closing regulators.

LIABILITY: it is duty of the installer to follow the installation instructions in any detail, specifically point 6, 7 and 8 in order to guarantee the safety of the end-users.



MASONRY WORKS: for fire-rated doors the wall thickness must be at least 200mm. It's the customer's responsibility to keep the wall integral particularly in the anchor points of the door, the application of silicon on both sides of the doorframe perimeter. This is particularly valid for fire-rated doors.

FINISHING: the serial door is finished with an epoxy-polyester powder paint oven-baked at 180 °C. The surface is orange-skin and particularly resistant. In case an additional paint is desired we advise to follow these instructions:
 - make smooth the surfaces with sandpaper and dust them;
 - give a first hand of opaque 2 components epoxide using the product ALCEA EPOX 5203 / 0059 (beige);
 - finish the surfaces with enamels or paints to your choice.

CLEANING: the doors are supplied from the factory clean and packed. We suggest to use a clothe and soaped water only. Do not scratch the surfaces.

WARRANTY: the manufacturer gives warranty as per Italian law (C.C.1495). Any claim for missing or damaged goods have to be recorded by inserting a written remark in the delivery notes and must be notified the maximum within eight days from the date of materials receipt.

CURRENT CE MARKED ACCESSORIES FOR FIRE-RATED DOORS:

Std015 lock:		0497-CPD-4265/11	- EN 12209:2003/AC	- 3 M 3 1 0 C 2 H A 2 0
Hinges:		0789-CPD-2005	- EN 1935:2002	- 4 7 7 1 1 4 0 1 4
RC/STD closing regulator:		CPD-0425-1153	- EN 1158:2003	- 3 5 5/3 1 1 4

USE AND MAINTENANCE INSTRUCTIONS FOR PROGET DOORS

All fire-rated doors located in escape routes need regular maintenance in order to verify that no damage occurred and that they close regularly. The scheduled maintenance shall guarantee that the leaf swings correctly and that the self closing mechanism works properly. The doors shall be kept free from any obstructions.

Any 5.000 opening cycles but at least every 6 months the following operations shall be carried out:

- lubricating the ball-bearing hinge;
- lubricating the spring hinge and the spring after removing the tension pin;
- wind up the spring inserting the tension pin. Verify that the closing force is sufficient to shut the door if opened to 30±2°;
- lubricating the lock and the latch.

For double leaf doorsets additional controls shall be carried out:

- verify the functionality of the secondary leaf's rods and lubricate its guide rail;
- clean the hole of the floor catch set;
- lubricate the lock and the self-locking device (top onto passive leaf);
- verify the regular functionality of the closing regulator (arm position perpendicular to the main leaf); lubricate the mobile parts of the closing regulator.

Verify the regular functionality of the doors accessories (handle, panic bar, overhead doorcloser etc.). Their mobile parts shall be lubricated too, following the dedicated instructions.

In case of irregular functioning of the door or its accessories contact an authorized installer or replace the damaged accessories.

Note: for lubrication use viscous products.

STORAGE INSTRUCTIONS:

It is duty of the company/person taking over the goods to store them in a suitable place so that they will be protected from the natural agents and from the direct sun rays. If during transportation or truck unloading it rains or snows on the goods it is necessary to remove immediately the nylon film from each leaf and doorframe, put the goods in vertical position to dry them appropriately. In case of external visible defects on doors, they have to be marked in the copy of the transportation document to be returned to the forwarder and notified to the manufacturer by registered mail within 48 hours. We remember that according to our general conditions intrinsic defects have to be notified to the manufacturer within 8 days from the delivery date by registered mail. Goods with defects never have be utilized or assembled, they should be stored at disposal for controls by the manufacturer appointed person.

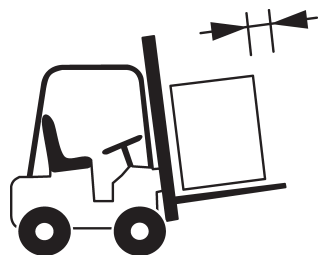

Move the materials with appropriate means.

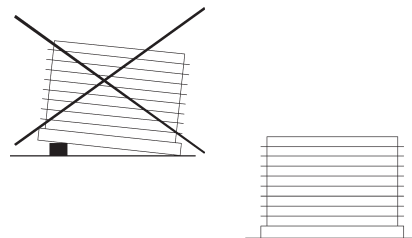

Store and handle the materials with care.



Assemble by qualified staff only.



Do not expose the materials to the natural agents.